

MDG

User Guide



eMEGA Fogger

(Revision A/a, April 2020, © MDG Fog Generators Ltd)



Les Générateurs de Brouillard MDG Ltée / MDG Fog Generators Ltd
10301 avenue Pelletier, Montréal, Québec, Canada H1H 3R2
Tel. 514-272-6040 / 800-663-3020 - Fax 514-722-3229
www.mdgfog.com e-mail : info@mdgfog.com



Intentionally left blank

TABLE OF CONTENT

Section	Page
TABLE OF CONTENT	3
USER'S GUIDE	4
How to read this user's guide	4
Qualified Personnel	5
Need a little Help?	5
Copyright notice	5
BASIC DESCRIPTION	6
INSTALLATION	8
WORKING WITH THE eMEGA	9
The Keyboard	10
Lcd saver	10
The Menu	11
Operating instructions	14
Starting Procedures	14
FAIL State	15
DMX Control	17
Bootloader	18
RDM Control	18
FOG FLUID	20
Replacing the fluid container	20
TROUBLESHOOTING	21
CABLE REQUIREMENTS	23
Connection to the main	23
DMX 512 connection	23
TECHNICAL SPECIFICATIONS	24
DIMENSIONS	25
WARRANTY	26
DECLARATION OF CONFORMITY	27
NOTES	28

USER'S GUIDE

Congratulations! You are now in possession of a MDG **eMEGA** fogger.

We hope this **eMEGA** fogger will bring you long hours of satisfaction.

Please read the following instructions carefully and completely before filling your fogger with the **MDG** Glycol-Based Fog Fluids and turning it on.



CAUTION

This appliance is not intended for use by persons (including children) with reduced physical, sensory or mental capabilities, or lack of experience and knowledge, unless they have been given supervision or instruction concerning use of the appliance by a person responsible for their safety. Children should be supervised to ensure that they do not play with the appliance.



CAUTION

If the supply cord is damaged, it must be replaced by the manufacturer, its service agent or similarly qualified persons in order to avoid a hazard.

HOW TO READ THIS USER'S GUIDE



WARNING and **CAUTION** are used throughout this manual to forewarn of possible danger to the users if precautions are not observed. As is customary in military and some commercial manuals, the precautions will always precede the steps to which it refers so that the users will be aware of any potential danger before performing the task.



WARNING and **CAUTION** labels are key equipment parts. Do not remove, change or cover these labels. If the labels are not readable, contact ***MDG FOG GENERATORS LTD.***

BOLD TEXT: Contains important information, cautionary steps and warnings that should be read and understood prior to installing the unit.

BOLD and ITALIC TEXT: pertains to product names and trademarks, proprietary names and products made by MDG FOG GENERATORS LTD.

Please read the following instructions carefully and completely before installing, pressurizing and turning on the fogger.

QUALIFIED PERSONNEL

MDG Fog Generators Ltd systems will perform as designed but are to be installed, operated, and serviced by trained personnel. Installation, operation and servicing of this equipment require trained personnel with technical skills in electrical theory and fluid dynamics. This manual is not a substitute for qualified technicians or local authorities on electricity, gas, fluid, or engineering, and therefore does not supersede, amend or void local safety installation practices. Please refer to local authorities for further information.

NEED A LITTLE HELP?

At MDG, we try our best to provide you with complete information for our products. Despite it all, sometimes, a little more is required due to the specifics of your project and installation. We're looking forward to go that extra mile for you.

Contact us:

By Phone: +1-800-663-3020 +1-514-272-6040

By Fax: +1-514-722-3229

By e-mail: info@mdgfog.com

On the Web: www.mdgfog.com

By Mail: **MDG Fog Generators Ltd.**
10301, Avenue Pelletier
Montréal, QC, H1H 3R2
Canada

Please note that our business hours are from 08h00 to 12h00 and from 12h30 to 17h00 (8:00AM to 12:00PM and 12:30PM 5:00PM), Eastern (GMT -5).

COPYRIGHT NOTICE

This User's Guide (Original Instructions) is copyrighted and all rights are reserved by MDG Fog Generators Ltd.

No part of this publication may be reproduced, transmitted, transcribed, stored in a retrieval system, or translated into any language or computer language, in any form or by any means, electronic, mechanical, magnetic, optical, chemical, manual or otherwise, without the prior written permission of MDG Fog Generators Ltd.

BASIC DESCRIPTION

The **eMEGA** fogger was designed with safety and reliability in mind. It is capable of generating pure white, non-toxic fog for as long as you have fluid (100% duty cycles).

The **eMEGA** is a variable output fogger capable of generating large volume of dense fog in a short period of time. This fogger must be used in a well-ventilated area.

At the heart of the **MDG fogger** is an electronic assembly that keeps the heat exchanger(s) at a very stable temperature, with three different types of fail-safe systems. Those three types of electronic fail-safe systems are designed to protect against over and under-heating conditions and against component failure. When an overheating condition is detected, or if the internal temperature of the fogger reaches 60°C (140°F), a safety circuit is triggered. This circuit removes the power to the heating elements, preventing hazardous conditions.

When an under-heating condition occurs, the fogger will stop producing fog until the temperature of the heating module is back within parameters.

The temperature of the heat exchanger is maintained within a narrow margin. If an error occurs (see FAIL State), the fogger will automatically shut down. When one of the safety systems is activated, the Fail state will be displayed on the LCD, in the Status Menu. Check the **FAIL State** and **Troubleshooting** paragraphs for diagnostics, then shut down the main power switch, wait 30 seconds, and then switch the fogger back on. If the failure persists, send your fogger back to an authorized service center for verification.

When « Fog On » mode is activated (DMX or Control Menu), the MDG **eMEGA** fogger will produce fog for as long as the ready level is reached (temperature) and all other control parameters are within specifications.

Never remove the power to a fogger while it is producing fog – See the **Shut down procedure**.



WARNING

- When not in use, **ALWAYS** switch off the power switch located on the back panel and **disconnect the AC line**.
- Never install above people.
- This **eMEGA** fogger must be installed in an upright position on a stable and leveled surface.
- Use in a well-ventilated area.
- Do not operate at less than 2 meters (6.5 ft.) from people.

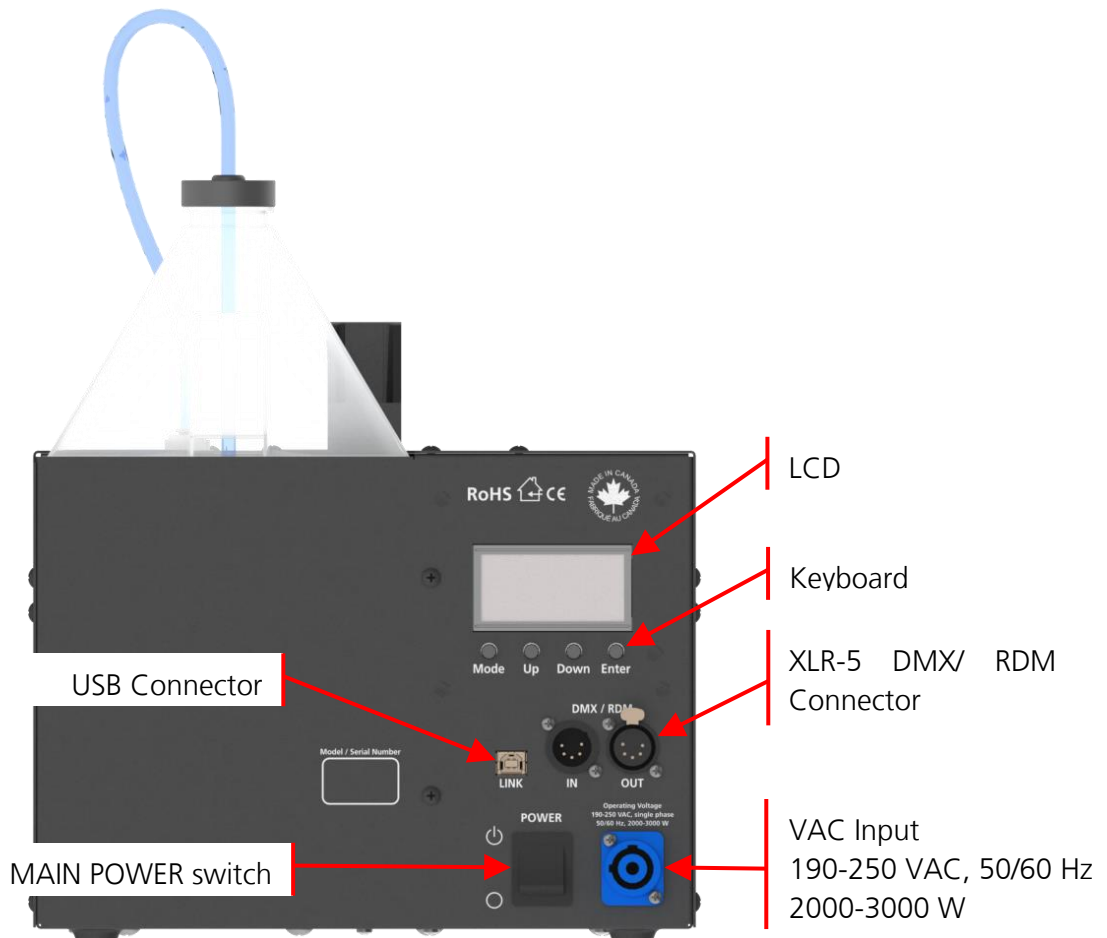
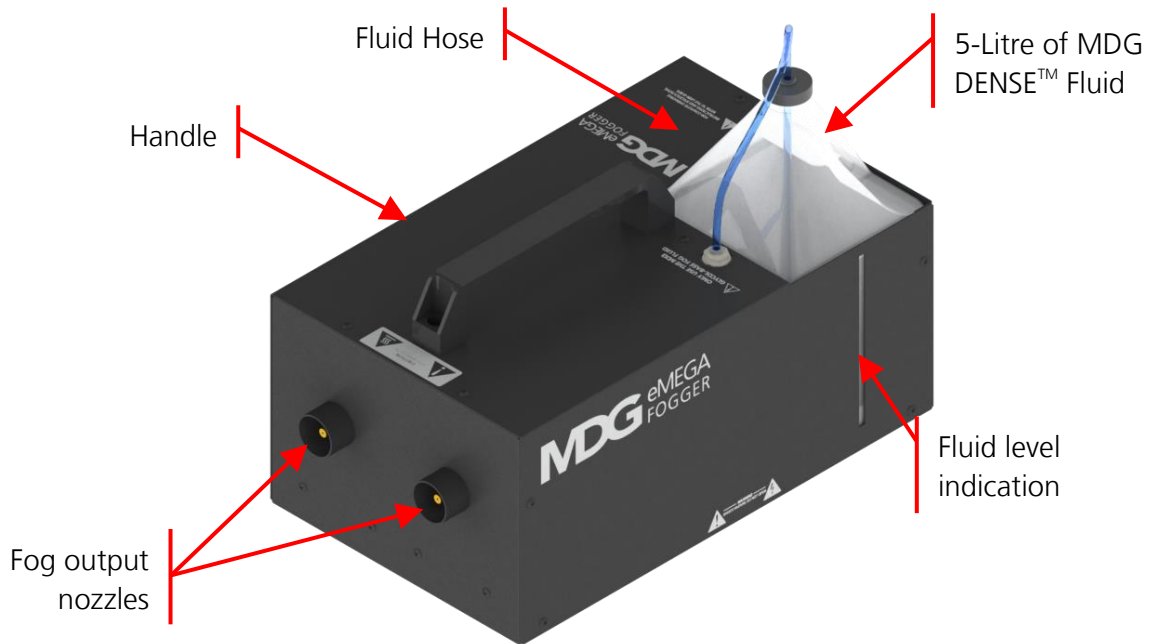

INSTALLATION

Exercise caution when selecting the location to install or use this equipment:

- Install the MDG **eMEGA** away from rain, wind, heavy dust or any harsh environment situations.
- Ensure available space for all electrical cable and DMX cables runs,
- The MDG **eMEGA** requires 2 m (6.56 ft) of clearance to the front.

Install a **MDG Glycol-based Fog Fluid** bottle in the fogger (see **Fog Fluid** paragraph).

Connect the data wiring (Male XLR-5 connector for DMX/RDM) if you are using a DMX or RDM controller.

Plug the PowerCON connector.

Connect the power cord 190-250 VAC, 50-60 Hz, 2815W nominal (2000-3000 W).

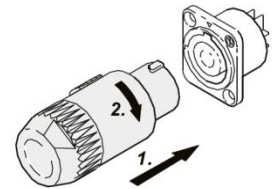

WORKING WITH THE eMEGA

The MDG **eMEGA** fogger is quite easy to operate and require no preventive maintenance.

Switch On the power.

The MDG **eMEGA** will display during four (4) seconds, the following message:

**MDG Fog Generators
BootLoader
Testing:**

The MDG **eMEGA** will then display during one (1) second, the following message:

**eMEGA
by
MDG Fog Generators Ltd
(V: x.xx – F: y.yyy)**

where 'x.xx' is the version of your fogger, and 'y.yyy' is the firmware of the program.

The program will load the configuration parameters saved in the EEPROM memory.

Finally, the screen will display the menu.

THE KEYBOARD

The user can scroll in the menu by using the buttons of the keyboard:

'Down' moves the selection to the next menu, or decrease a data value.

- When at the end of a list, the program moves back to the first item of this list.
- If the selected menu is a **data input menu**, keeping this key pressed will decrease the value more rapidly.
- In a **data input menu**, when the value reaches its minimum value, the program continues with the maximum value.

'Up' moves the selection to the previous menu, or increase a data value.

- If the item is the first of a menu, the program moves the selection to the last item of that menu.
- If the selected menu is a **data input menu**, keeping this key pressed will increase the value more rapidly.
- In a **data input menu**, when the value reaches its maximum value, the program continues with the minimum value.

'Mode' moves the last selection to the upper level

- This key has no effect in the first level.
- In a **data input menu**, pressing this key permit to exit the menu without changing any value (escape).

'Enter' confirms a selection or data value.

- This key selects the menu.
- In a **toggle menu**, this key confirms the selection and moves the cursor back to the upper level menu.
- In a **data input menu**, this key confirms the value of the data and moves the cursor back to the upper level menu.

LCD SAVER

The program can automatically switch off the LCD screen (menu display and backlight) if there is no keyboard activity. The user can choose between a 30 second and a 2 minutes delay in the **Settings Menu** (« SETTINGS ► LCD SAVER »).

When the LCD Saver is activated, just press any key of the keyboard to re-activate the LCD screen functions.

The user can also deactivate the LCD saver by selecting the OFF option.

THE MENU

The menu is divided in four (4) main menus:

- Status Menu summarizes all the state of the fogger. None of its sub menus can be modified.
- Control Menu allows the user to control locally the MDG **eMEGA**. All its sub menus can be set, as long as the fogger is not in DMX/RDM mode.
- Interface Menu allows the user to define or verify the communication via DMX/RDM.
- Settings Menu summarizes general configuration of the fogger.

The menu is refreshed every second.

- Items preceded by the « - » character are state messages or parameters, updated by the program. The user cannot modify them.
- Items preceded by the « > » character are control parameters.
- The user, within specific ranges or choices, can MODIFY them. In user input mode, the value or the choice is preceded with the « ? » character.

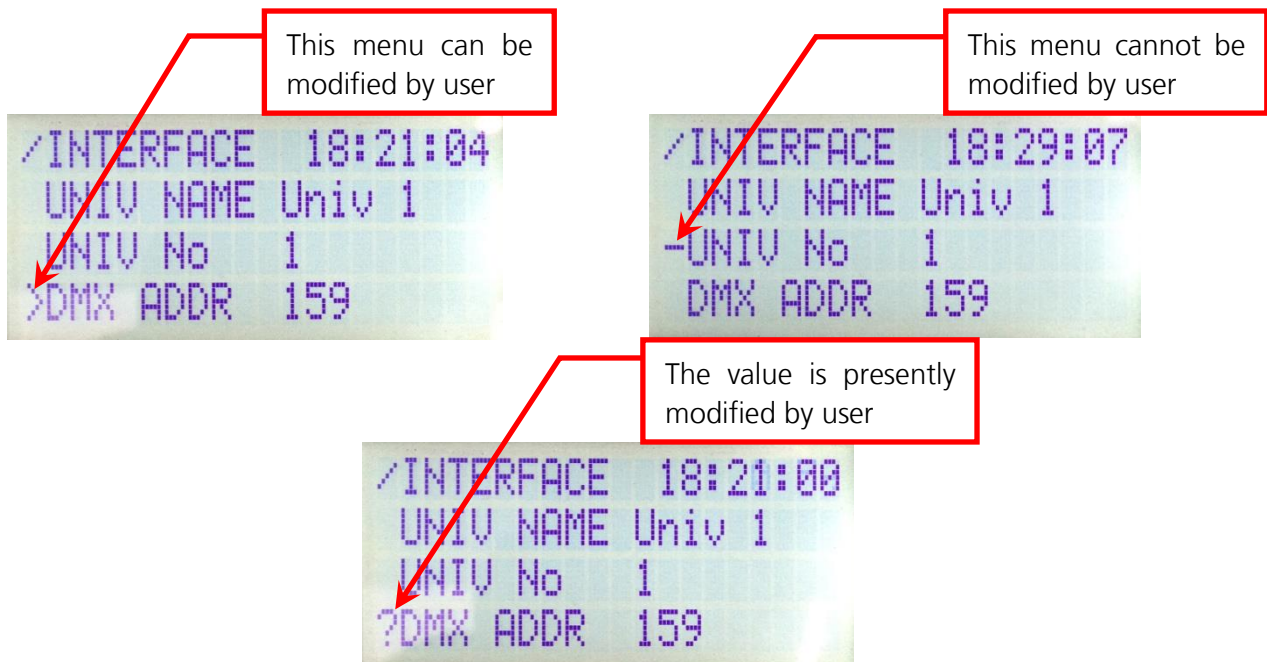

The tree menu architecture is explained below. Items highlighted in blue are state menu (---), and those highlighted in yellow are control menu (---).

STATUS

STATE

UNIT OFF
xx% HEAT
READY
FOG ON
FAIL

Status menu

Status **State**

- the fogger is **off**
- the fogger is **heating**, but not ready
- the fogger is **ready** to produce fog
- the fogger is producing **Fog**
- the fogger is off, due to a **failure** (see diagnostic)

ERROR

Error message when **State = FAIL** (see diagnostic)

TEMP.

TOO LOW
OK
TOO HIGH

Temperature status (heating module)

- temperature **too low**
- temperature within specifications (**ready**)
- temperature **too high**

PCB TEMP

Temperature of the board (see Units)

RUN TIME

xx.x

Total Run Time in decimal hours

FOG TIME

xx.x

Total Fog Time in decimal hours

LAST ERR

yyyyy

Code for the Last five (5) errors

See **Fail State** paragraph

CONTROL

UNIT

OFF
ON

Control menu

Unit toggle

- the fogger is **off**
- the fogger is **on**

« Normal Mode » PERSONALITY

OUTPUT

xxx

Fog **Output**, from low (0) to high (255)

« Burst Mode » PERSONALITY

BURST DUR

xxx

1/10 sec **Burst** duration, for 0.5 (0) to 26.0 (255)

FOG

OFF
ON¹

Fog **Control**

- No output
- Fog output

PERSO.

xxx
NORMAL
BURST

Personality toggle

- Normal Mode (Variable Output)
- Burst Mode (Very High Output, Short Duration)

¹ In Burst Mode, the generator produces a **UNIQUE** burst of fog. The user must switch back the menu to OFF to be able to redo another burst of fog.

INTERFACE

COMM.	----
	AUTO
	LOCAL
	DMX
DEV LABEL	yyyyyy
DEV ID	yyyyyy
DMX ADDR	yyy
CHAN. 1	yy
CHAN. 2	yy
CHAN. 3	yy

SETTINGS

UNITS	----
	°C
	°F
LCD SAVER	----
	30 s
	2 mn
	OFF
VERSION	x.xx
FIRMWARE	x.xx

Network /DMX/RDM Menu

Communication toggle

- the fogger is controlled by **DMX/RDM** if a signal is present, or **locally** if there is no signal
- the fogger is controlled by the **keyboard ONLY**
- the fogger is controlled by **DMX/RDM ONLY**

RDM Device Name

RDM Device ID

DMX Address (1 to 510) Network / DMX / RDM

DMX channel #1 value (0-255)

DMX channel #2 value (0-255)

DMX channel #3 value (0-255)

Settings menu

Units toggle

- temperature in **Celsius**
- temperature in **Fahrenheit**

LCD Saver Mode

- LCD saver is activated after 30 s
- LCD saver is activated after 2 min
- LCD Saver is Off

Model Version

Program Firmware

OPERATING INSTRUCTIONS

The MDG **eMEGA** fogger can be controlled either locally, with the keyboard, via DMX (see *DMX control and RDM Control*). This paragraph focuses on **local control**.

Starting Procedures

Powered up the fogger, the control program configures the Input/Output and loads the configuration parameters, saved in the EEPROM memory.

At this point, the MDG **eMEGA** switches to stand-by mode, and most of the electronic controls are off.

When the fogger is manually switched to «**UNIT ON**» mode («UNIT ▶ ON»), the program starts the heating cycle («STATE = % HEAT»), which will last approximately 7 minutes.

When the temperature reaches its operating level, the **eMEGA** Fogger is ready to produce fog («STATE = READY»).

NOTES:

Always check that the fog fluid hose and pumps are primed prior using the MDG eMEGA fogger.

This is particular critical after you have refilled the fog fluid bottle, or if you have not used the fogger during a long period.

*To prime the **eMEGA** fogger, do a fog burst of approximately 10 sec.*

Fog Production

- Normal Mode

The amount of the fog emission can be controlled by adjusting the fog output («CONTROL ▶ OUTPUT»), while the emission is controlled with the Fog menu set to ON («CONTROL ▶ FOG ▶ ON»).

- Burst Mode

When the **fog** menu is toggle to **ON**, the MDG **eMEGA** fogger will produce fog at very high output during a period corresponding to the **burst** duration («CONTROL ▶ BURST DUR»), in 1/10th of seconds

When the **burst** of fog is finished, the user will need to reset the **fog** menu to **OFF** («CONTROL ▶ FOG ▶ OFF») to be able to restart a new burst.

During a fog burst, switching **fog** menu to **OFF** will abort the running fog burst.

The MDG **eMEGA** fogger will produce fog as long as the control parameters are within specifications, and the fog fluid bottle filled.

If a critical problem occurs, the program shuts down automatically the fogger, and displays an error message in the **State Menu** (see *Fail State*).



WARNING

Never power off a fogger while it is producing fog – See the shut down procedure.

Shut down procedure

Never shut down the MDG **eMEGA** fogger while producing fog.

Power off the fogger observing the following sequence:

- **Switch off** the fog emission («CONTROL ▶ FOG ▶ OFF»),
- Switch the fogger «UNIT OFF» mode («CONTROL ▶ UNIT ▶ OFF»),
- Power off the **MDG eMEGA** fogger, by switching off the “MAIN POWER SWITCH”.

Switching directly the fogger in «**UNIT OFF**» mode by DMX will yield the same result as above. Wait for all the cycles to complete before powering off the fogger.

FAIL State

FAIL state mode is initiated if any critical error occurs.

In this state, the **MDG eMEGA** is **off**, awaiting an action from the user.

A critical error is always displayed in the **Status Menu** («STATUS ▶ ERROR»), as well as the five (5) last critical errors («STATUS ▶ LAST ERR»).

- **ERROR = HEATER** **LAST ERR CODE = 6**

This error will occur if the temperature of the heating module is not increasing with the proper thermal ramp.

This is generally due to a heater cartridge(s) problem. Shut down the fogger and restart it. Check the heating process with the value of the Status («STATUS ▶ STATE ▶ xx% HEAT»). If the percent is not increasing, the heater cartridges have failed.

- **ERROR = T. HIGH** **LAST ERR CODE = 8**

This error will occur if the temperature of the heating module is too high.

This is generally due to an electronic problem. Shut down the fogger and restart it.

DMX CONTROL

The MDG **eMEGA** can be controlled via a DMX512-A USITT standard protocol.



WARNING

Activating the «**DMX**» mode («**INTERFACE ▶ MODE ▶ DMX**»), controls the MDG eMEGA only by DMX signal. If the DMX wire is **unplugged** or DMX **signal is lost**, the fogger **initiates an automatic shutdown procedure**.

Activating the «**AUTO**» mode («**INTERFACE ▶ MODE ▶ AUTO**»), controls MDG eMEGA by DMX, only if there is a signal. If the DMX wire is **unplugged** or DMX **signal is lost**, the fogger **keeps the last DMX values**.



WARNING

In «**AUTO Mode**», DMX commands always take precedence over Local commands.

The MDG **eMEGA** provides a simple way to check if there is DMX signal:

```

/INTERFACE 18:30:01
>COMM. AUTO
DEV LABEL ONE-14100
DEV ID 1
    
```

No DMX Signal

```

/INTERFACE .18:30:33
>COMM. AUTO
DEV LABEL ONE-14100
DEV ID 1
    
```

DMX Signal

The user can change the DMX Start Address in the Interface Menu («DMX Add»), and choose any value between 1 and 510 (512, last DMX channel).

The user can change the DMX Start Address in the Interface Menu («DMX Add»), and choose any value between 1 and 511 (512, last DMX channel).

The fogger uses three (3) DMX channels, but has two different personalities:

- Channel 1 **0 (0%) < UNIT OFF < 128 (50%) < UNIT ON < 255 (100%)**
- Channel 2 **0 (0%) to 255 (100%), FOG OUTPUT (from minimum to maximum)**
 OR 0 (0.1 s) to 255 (25.5 s), BURST DURATION
- Channel 3 **0 (0%) < FOG OFF ≤ 128 (50%) < FOG ON ≤ 255 (100%)**

These channels have the same behaviour that the menus of the local interface (see **Operating instructions** paragraph).

BOOTLOADER

The MDG **eMEGA** uses a BootLoader, also called boot manager. This program is a firmware (software embedded in a hardware device) located into the non-volatile memory of the microcontroller unit (MCU) that allows in-circuit reprogramming of the device using its USB communication port.

To upgrade the firmware, you will need:

- a computer running under Windows, with a USB 2.0 connector
- special driver for the USB, included in the package,
- a standard USB 2.0 cable, A to B Male/Male type

Contact the MDG Service to have the last package firmware upgrade for the MDG **eMEGA**.

RDM CONTROL

The MDG **eMEGA** can be controlled via a RDM ANSI E1.20 protocol, an intelligent bi-directional communication utilizing the DMX512 data link.

RDM allows a console or other controlling device to discover and then configure, monitor, and manage intermediate and end-devices connected through a DMX512 network. RDM provides for intelligent control of devices on a DMX512 network, which has not been previously available outside of proprietary networks

RDM Control has the same functionalities than the DMX Control (see *DMX Control*) with bi-directional functions allowing the user to read or write specific functions.

The RDM supported parameters implemented in the MDG **eMEGA** are summarized in the following table.

RDM Parameter ID's	Value	GET Allowed	SET Allowed	Comments
DISC_UNIQUE_BRANCH	0x0001			
DISC_MUTE	0x0002			
DISC_UN_MUTE	0x0003			
QUEUED_MESSAGE	0x0020	✓		
STATUS_MESSAGES	0x0030	✓		
SUPPORTED_PARAMETERS	0x0050	✓		
PARAMETER_DESCRIPTION	0x0051	✓		
DEVICE_INFO	0x0060	✓		
PRODUCT_DETAIL_ID_LIST	0x0070	✓		
DEVICE_MODEL_DESCRIPTION	0x0080	✓		eMEGA, Fogger
MANUFACTURER_LABEL	0x0081	✓		MDG Fog Generators Ltd
DEVICE_LABEL	0x0082	✓	✓	
SOFTWARE_VERSION_LABEL	0x00C0	✓		
DMX_PERSONALITY	0x00E0	✓	✓	1
DMX_PERSONALITY_DESCRIPTION	0x00E1	✓		
DMX_START_ADDRESS	0x00F0	✓	✓	1 to 510
SLOT_INFO	0x0120	✓		
SLOT_DESCRIPTION	0x0121	✓		
DEFAULT_SLOT_VALUE	0x0122	✓		
IDENTIFY_DEVICE	0x1000	✓	✓	LCD flashes
RESET_DEVICE	0x1001		✓	0x01/0xFF Reset (Warm)
MDG_GENERATOR_STATE	0x8002	✓		ASCII text (Up to 20 characters)
MDG_LCD_SAVER	0x8004	✓	✓	Unsigned Byte (0=30 s, 1=2 min, 2=Off)
MDG_COM	0x8005	✓	✓	Unsigned Byte (0=AUTO, 1=LOCAL, 2=DMX)

Table 1: RDM Supported Parameters.

FOG FLUID

Operate the **eMEGA** fogger only with the MDG Glycol-based Fog Fluids: the **MDG DENSE™**, the **MDG WB2™** or the **MDG LOW FOG™**.

Make sure that no other liquids or particles are mixed or added to the **MDG Glycol-based Fog Fluid**.

The **MDG Glycol-based Fog Fluids** produce a pure, white, non-toxic fog.

MDG Glycol-based Fog Fluids are available at authorized MDG distributors or dealers.

Available in 4 L (1 US gallon), 5 L (Europe Only), 20 L (5.3 US gallon), 205 L (55 US gallon) and 1000 L (264 US gallon).



REPLACING THE FLUID CONTAINER

Verify the fluid level of the bottle by looking through the opening, on the side of the Fogger. If level is insufficient, change the bottle or refill.

The fluid bottle capacity for the **eMEGA** fogger is 5-litre.

To prime the eMEGA fogger, do a fog burst of approximately 10 sec.



WARNING

Use only **MDG Glycol-based Fog Fluids**. Not doing so will void the warranty and may damage the fogger.



WARNING – DO NOT OPERATE WITHOUT FLUID.

TROUBLESHOOTING

Contact MDG, if symptoms are not listed, or if the provided solutions fail to resolve the issue.

Table 2: Symptoms and Solutions

Symptoms	Probable Causes and Suggested Actions
The fogger does not switch on	<ul style="list-style-type: none"> • Verify that AC power cord is properly connected on both ends. • Check the fuse or the breakers of your VAC entry. The wattage of the fogger is around 2815 W. • Verify the AC voltage on the power cord. 190~250 VAC.
The fogger does not produce fog	<ul style="list-style-type: none"> • Verify that the Unit is ON «UNIT ▶ ON» • Verify that the UNIT is READY «STATE = READY» <p>The fogger needs approximately seven to eight (7 to 8) minutes to be ready. While the heating module is heating, the % HEAT must vary, in State menu.</p> <ul style="list-style-type: none"> • Verify that the Unit is not in a FAIL state «STATE = FAIL» <p>If Yes, check the symptoms below</p> <ul style="list-style-type: none"> • Verify the communication mode. «Mode» <p>You cannot control the fogger locally if you are in DMX mode, and vice-versa.</p> <ul style="list-style-type: none"> • If you are in DMX mode: <ul style="list-style-type: none"> • Verify the cable • verify the DMX address and the channels • Verify the Universe parameters and the DMX Start Address
	.../...

Symptoms	Probable Causes and Suggested Actions
<p>« STATE = FAIL» VERIFY THE ERROR MESSAGES</p>	<ul style="list-style-type: none"> • Error = HEATER <ul style="list-style-type: none"> • This is a heating timeout, due to a cartridge heater problem. • Restart the fogger and check the heating status «STATUS ▶ STATE = xx% HEAT». If the heating value is not progressing, you have a cartridge problem. • Restart the fogger in 115 VAC. <p>Please contact the Service if this problem persists.</p> • Error = T. HIGH <ul style="list-style-type: none"> • Restart the fogger. This is generally due to an electronic problem. <p>Please contact the Service if this problem persists.</p> • Error = T. SAF <ul style="list-style-type: none"> • Restart the fogger. This is generally due to an electronic or sensor problem. <p>Please contact the Service if this problem persists.</p> • Error = PCB. HIGH <ul style="list-style-type: none"> • Stop the fogger for few minutes, if it is possible • Try to change the position of the fogger to a cooler place <p>Please contact the Service if this problem persists.</p> • Error = WD RESET • Restart the fogger. <p>Please contact the Service if this problem persists.</p>

CABLE REQUIREMENTS

CONNECTION TO THE MAIN

If the supply cord is damaged, it must be replaced by a special cord or assembly available from the manufacturer, or its distributing / service agent.

- Operating voltage: 190-250 VAC, single phase. 50/60 Hz, 2815 W nominal (2000-3000 W).
- Ground / Earth connection **REQUIRED**.
- Cable: 2 mm² (14 AWG), 3-wire, 105 °C copper, 300 V
CE UL/CSA compliant cable

- Cable Preparation: Da = 9.5 [0.374"] - 15.0 [0.59"]

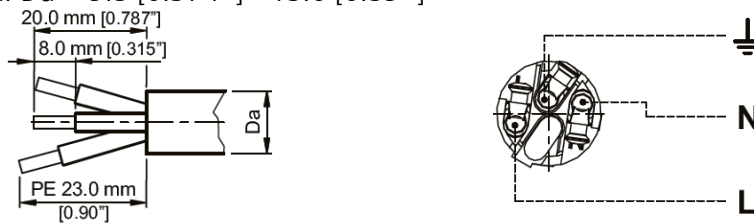

- Cable Assembly

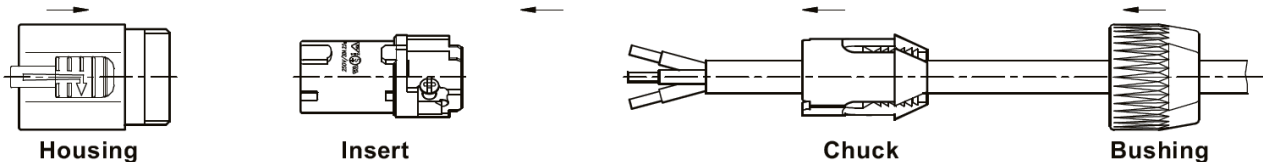

1. Put bushing and chuck onto the cable
2. Prepare cable as shown above
3. Insert the wire into the terminals and fasten the clamping device by a flat screw driver
4. Push insert and chuck into housing (pay attention to the guiding keyway!)
5. Fasten bushing by means of a fork wrench ¾", min. Torque 2.5 Nm (1.8 lb-ft)

DMX 512 CONNECTION

- DMX/RDM data: Dual twisted pair 0.75 mm (22 AWG) + shield, XLR-5 type connector, CE UL/CSA compliant cable.
- Wiring XLR Connectors:

1 – Shield	3 - Signal (+)	5 – Not connected
2 - Signal (-)	4 – Not connected	

TECHNICAL SPECIFICATIONS

Series	Fogger Series
Maximum fog output (per minute):	150 m ³ (5,000 ft ³), in Normal Mode
Fog colour:	Pure white
Particle size:	1 to 3 microns
Fluid consumption:	3.5 L (0.92 US gal) per hour
Fluid type:	MDG Dense, Low Fog or WB2 Fog Fluid ONLY M.S.D.S. available on request
Fluid capacity:	5 L (1.32 US gal) bottle
Warm-up time:	8 minutes
Operating voltage:	190-250 VAC, 50/60Hz, 1 phase Ground / Earth connection REQUIRED
Power consumption:	2815 W nominal (2000-3000 W)
Control signal:	Manual (4 buttons keyboard + LCD) USB (diagnostic & Bootload) DMX / RDM Protocol
Operating temperature:	0 °C to 50 °C (32 °F to 122 °F)
Operating humidity:	90 % relative humidity @ 50 °C (122 °F), non-condensing
Storage temperature:	-40 °C (-40 °F) to 60 °C (140 °F)
Storage humidity:	80% relative humidity @ 60 °C (140 °F)
Approval	CE and ETL field approved
Dimensions	26 cm (10") H x 28 cm (11") W x 49 cm (19") L
Weight:	16 kg (35 lb)
Shipping Weight:	27 kg (60 lb) with flight case

DIMENSIONS

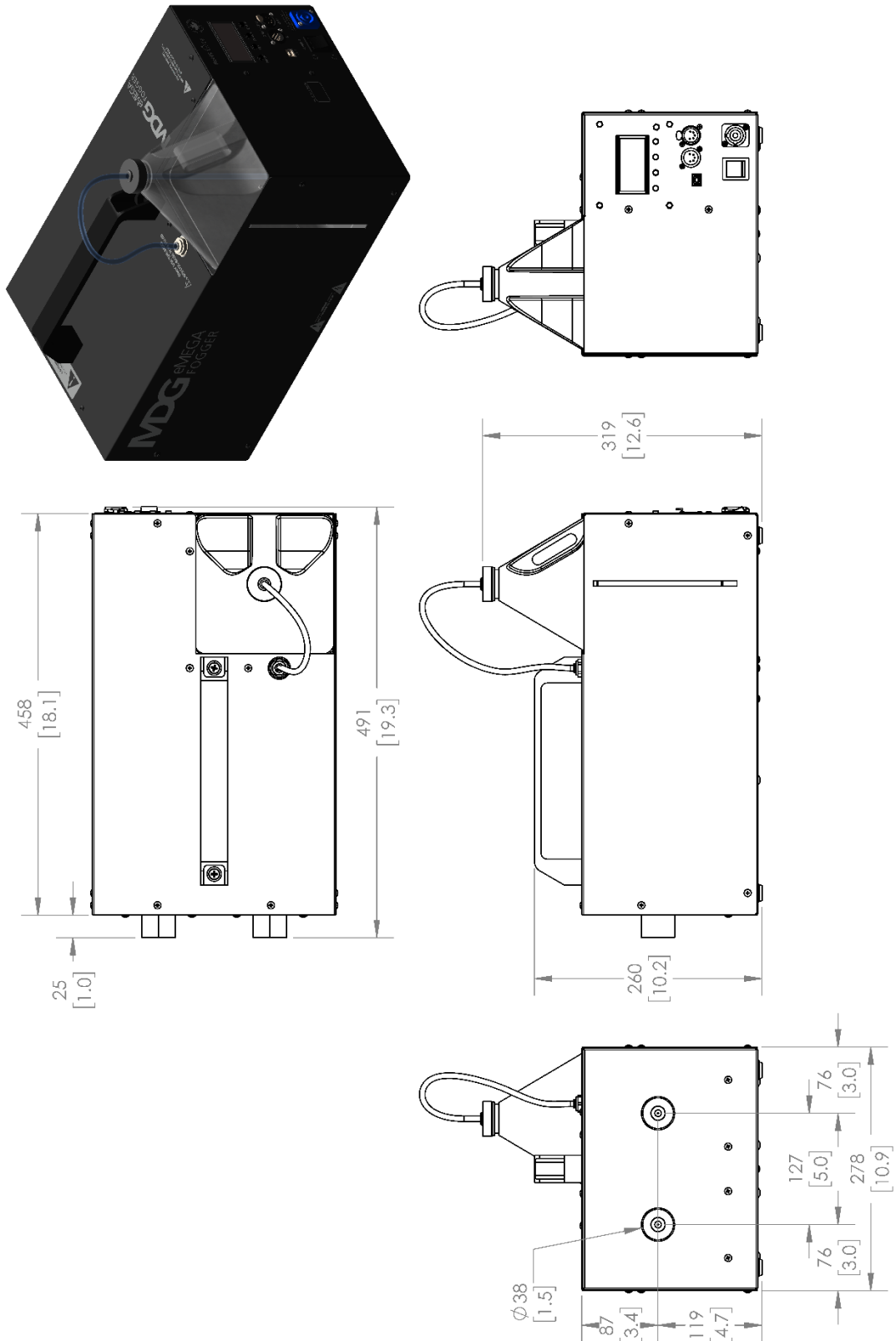

WARRANTY

When installed and operated as recommended, **MDG Fog Generators Ltd** guarantees that this product will remain free of defects in parts and labour for a period of two (2) years from the moment it is delivered. This warranty does not apply if the product has been modified without our written authorization, or repaired without a written authorization from MDG or one of its authorized service centres, or if it is used under conditions for which it has not been designed, or if any other fluid than the **MDG Glycol -based Fog Fluids** has been used. **MDG Fog Generators Ltd** is not responsible for any damages resulting from a faulty installation or from abusive use of the product.

If any device is found unsatisfactory under the terms of this warranty, **MDG Fog Generators Ltd** will repair or replace it free of all charges, except transportation costs.

This warranty applies only to the product itself and **MDG Fog Generators Ltd** declines responsibility for any losses, costs, or damages resulting from its use.

MDG Fog Generators Ltd shall not be liable for consequential damage in case of any failure to meet the conditions of any warranty or shipping schedule, nor will claims for labour, loss of profits, repairs, or other expenses incidental to replacement be allowed.

The repair or replacement of the product, by **MDG Fog Generators Ltd** shall constitute fulfilment of all obligations to the purchaser.

No other guarantees or warranties, expressed or implied, are made by **MDG Fog Generators Ltd** in connection with its products. This warranty is non-transferable and applies to the original purchaser only.

To obtain satisfaction under the terms of this warranty, contact your local sales office, and we will be pleased to help you.

DECLARATION OF CONFORMITY



EC DECLARATION OF CONFORMITY

According to IEC/ISO 17050

We, **MDG Fog Generators Ltd**
10301 ave Pelletier
Montreal, QC, Canada, H1H 3R2

declare under our sole responsibility, that the product including options or accessories

Fog Generators models: Me1, Me2, Me4 and Me8,
MAX 3000 APS, MAX 5000 APS and MAX 5000 APS H.O.
ATMe, ATMOSPHERE APS and ATMOSPHERE APS H.O.
ICE FOG Q and ICE FOG Compact
MM, MINI SINGLE, SINGLE and DUAL

to which this declaration relates, is in conformity with the following standards:

IEC 60335-1: 2001 (Fourth Edition) incl. Corr.1:2002 + A1:2004 + A2:2006
Household and similar electrical appliances – Safety/Part 1, September 2006
CISPR 22:2008-09/EN 55022, Class B
IEC 61000-6-1:2005/EN61000-6-1:2007, (EMC)-Part 6-1
FCC PART 15, Subpart B, class B

By conformance with the standards referenced, the product follows the provisions of the directives listed below:

2006/95/EC Low Voltage Directive
2004/108/EC EMC Directive
2011/65/EU RoHS2 Directive

Martin Michaud, President

August 17, 2012
Montreal, Canada

